

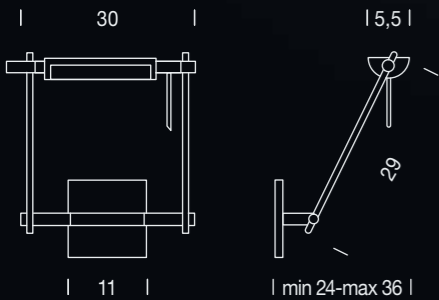





LOGO 300-9

DESIGN MARIO BARBAGLIA, MARCO COLOMBO 1991



ARMS
WALL SUPPORT

-   LOG KDD 32
-   LOG KDH 31
-   LOG KNN 31

250W, R7S, QT-DE,
LINEAR HALOGEN, 114 mm



CE LOGO 300-9 DESIGN MARIO BARBAGLIA, MARCO COLOMBO



Materiali Bracci in acciaio o alluminio, diffusore in rete di acciaio. **Finiture e colori** Grigio argento, cromo/grigio argento, nero.

Materials Arms in steel or aluminium, diffuser in steel net. **Finishes and colours** Silver grey, chrome/silver grey, black.

Matériaux Bras en métal, diffuseur en tôle perforée. **Finition et couleurs** Gris argent, chrome/gris argent, noir.

Materialien Arme aus Stahl oder Aluminium, Diffusor aus Stahlnetz. **Ausführungen und Farben** Silbergrau, verchromt/silbergrau, schwarz.

Materiales Brazos en acero o aluminio. Difusor en red de acero. **Acabado y colores** Gris plata, cromado/gris plata, negro.